

Contacteurs
 Contactors
 Schütze
 Contattori
 Contactores
 Контакторы
 接触器

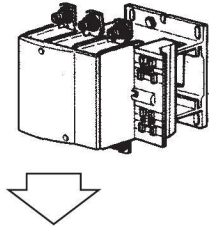

CR1-F150
 CR1-F185
 CR1-F265

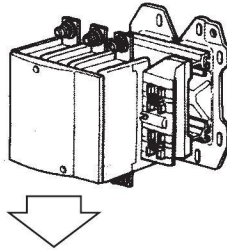

CR1-F400
 CR1-F500

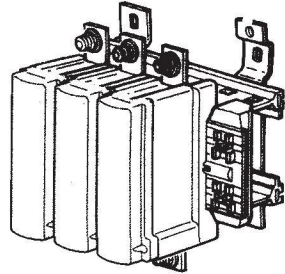

CR1-F630

"For Motor Starting Use Schneider Electric Overload Relay Series LR".
 "Для запуска двигателя используйте реле перегрузки Schneider Electric серии LR".

⚠ DANGER / DANGER / PELIGRO / GEFAHR / PERICOLO / PERIGO / ОПАСНО / 危險

<p>HAZARD OF ELECTRIC SHOCK, EXPLOSION, OR ARC FLASH Disconnect all power before servicing equipment. Failure to follow these instructions will result in death or serious injury.</p>	<p>RISQUE D'ÉLECTROCUTION, D'EXPLOSION OU D'ECLAIR D'ARC ELECTRIQUE Coupez toutes les alimentations avant de travailler sur cet appareil. Le non-respect de ces instructions provoquera la mort ou des blessures graves.</p>
<p>PELIGRO DE DESCARGA ELÉCTRICA, EXPLOSIÓN O ARCO ELECTRICO Desconecte todas las alimentaciones antes de manipular el producto. Si no se siguen estas instrucciones provocará lesiones graves o incluso la muerte.</p>	<p>GEFAHR VON ELEKTRISCHEM SCHLAG, EXPLOSION ODER LICHTBOGEN Vor dem Arbeiten am Gerät alle Spannungsversorgungen abschalten. Die Nichtbeachtung dieser Anweisungen führt zu Tod oder schwereren Verletzungen.</p>
<p>RISCHIO DI SCARICA ELETTRICA , ESPLOSIONE O ARCO ELETTRICO Scollegare l'apparecchio da tutti i circuiti di alimentazione prima di qualsiasi intervento. Il mancato rispetto di queste istruzioni provocherà morte o gravi infortuni.</p>	<p>RISCO DE ELECTROCUSSÃO, DE EXPLOSIÃO, OU DE ARCO ELÉCTRICO Desconecte todas as alimentações antes de manipular o produto. A não observância destas instruções resultará em morte, ou ferimentos graves.</p>
<p>Опасность поражением электрическим током, опасностью взрыва или вспышки дуги. Перед обслуживанием или ремонтом убедитесь, что питание отключено. Несоблюдение этих инструкций приведет к смерти или серьезной травме.</p>	<p>可能有触电、爆炸或者电弧灼伤的危險 在此电力设备上进行工作时 请先切断所有电源。 若违背这些说明，不遵循上述说明将导致人员伤亡。</p>

W9 1468387 0131 07
 01 - 2017
 1/12



RSPSupply - 1-888-532-2706 - <https://www.RSPSupply.com>
 See the product details here

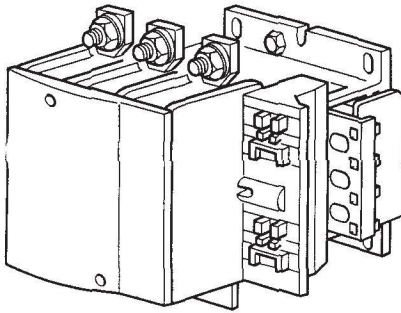

LX0-F ...



LX0-F ...

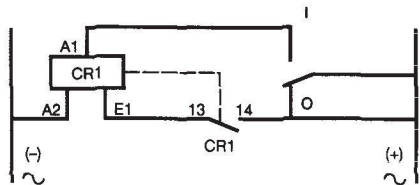
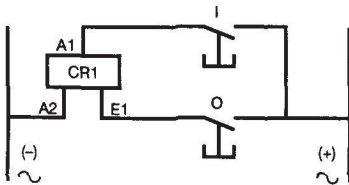
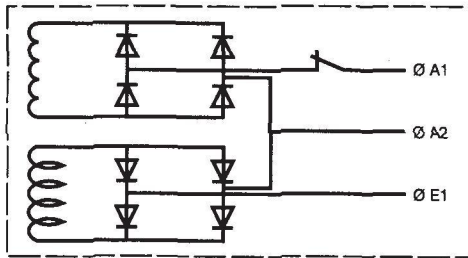

LA DN 10
01

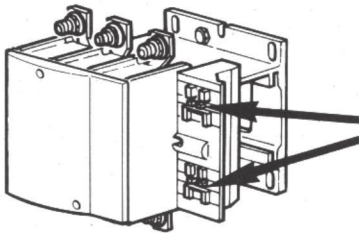
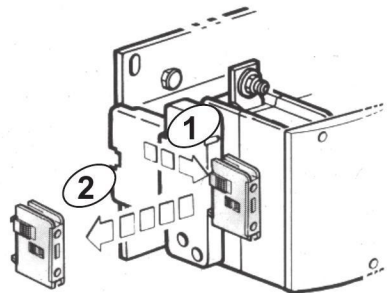
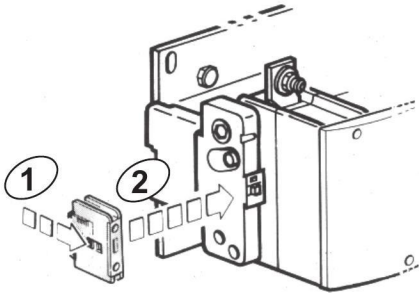

+

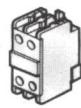

LA DN.

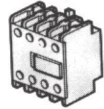

LA DN.
LA DC.
LA1 D.

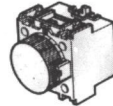

LA DS.
LA DT.
LA DR.

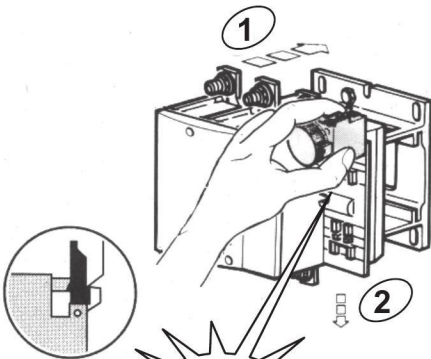

Click!

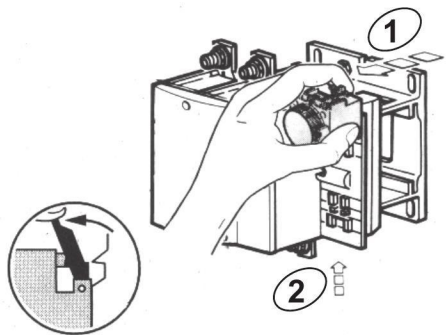

CR1-F150 ... 265

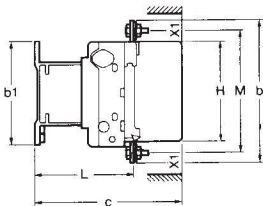
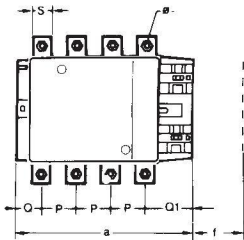
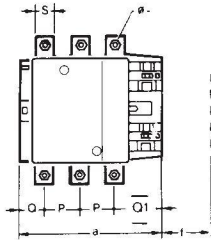

CR1-F400 ... 500

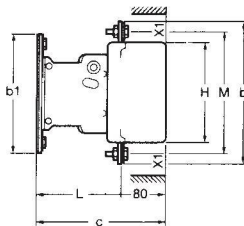
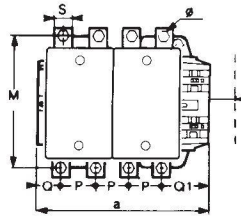
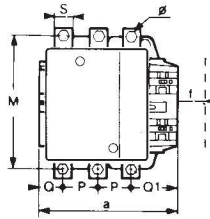

CR1-F630

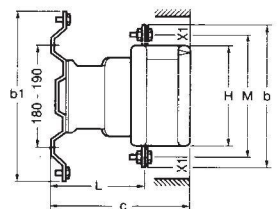
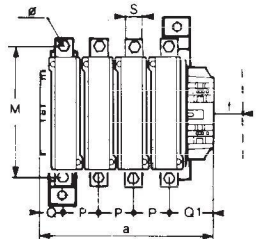
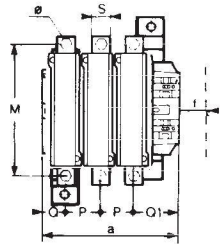

mm	CR1-F150		CR1-F185		CR1-F265	
	150	1504	185	1854	265	2654
a	163,5	200,5	168,5	208,5	201,5	244,5
P	40	40	40	40	48	48
Q	26	26	29	29	39	34
Q1	57,5	55,5	59,5	59,5	66,5	66,5
S	20	20	20	20	25	25
Ø	M8	M8	M8	M8	M10	M10
f	131	131	130	130	147	147
b	170	170	174	174	203	203
b1	137	137	137	137	145	145
M	150	150	154	154	178	178
H	124	124	127	127	147	147
c	171	171	181	181	213	213
L	107	107	113,5	113,5	141	141
X1						
200...500V	10		10		10	
660...1000V	15		15		15	

inches = mm x 0.0394

mm	CR1-F400		CR1-F500		CR1-F630	
	400	4004	500	5004	630	6304
a	213	261	233	288	309	389
P	48	48	55	55	80	80
Q	43	43	46	46	60	60
Q1	74	74	77	77	89	89
S	25	25	30	30	40	40
Ø	M10	M10	M10	M10	M12	M12
f	146	146	150	150	181	181
b	206	206	238	238	304	304
b1	209	209	209	209	280	280
M	181	181	208	208	264	264
H	158	158	172	172	202	202
c	219	219	232	232	255	255
L	145	145	146	146	155	155
X1						
200...500V	15		15		20	
660...1000V	20		20		30	

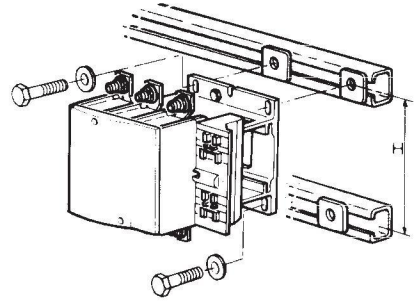
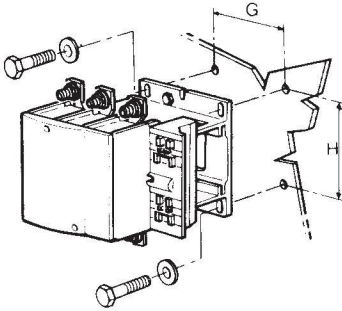
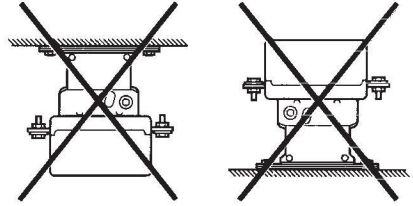
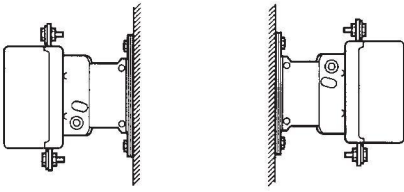

CR1-F	150/1504 185/1854	265/2654	400/4004 500	5004	630	6304
G (mm)	80	96	80	140	180	240
H (mm)	110 - 120		170 - 180		180 - 190	

CR1-F.	a (mm)	C (N.m)
150/1504/185/1854	13	18
265 ... 5004	16	35
630/6304	18	58

inches = mm x 0.0394

lb-in = N.m x 8.85

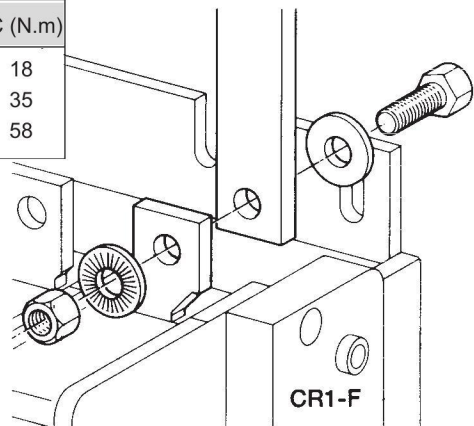
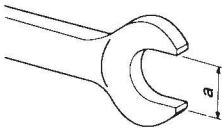

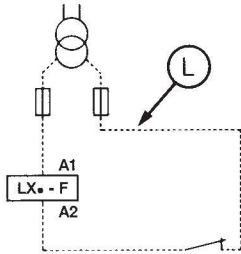
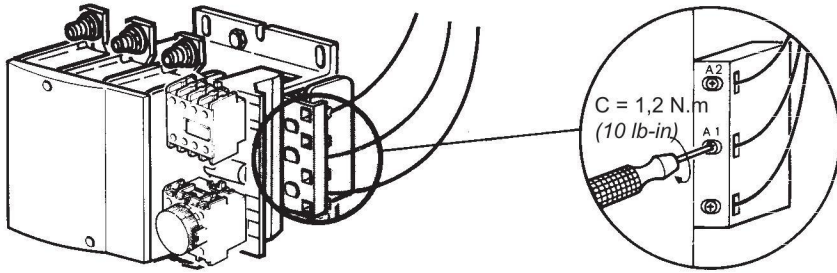

C = 1,2 N.m
C = 10 lb-in

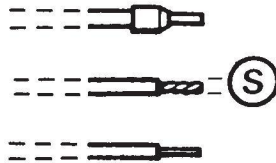

CR1-F150 ... 265		
LX-F ~ ou ≡	L ≤ ... m	S ≥ ... mm ²
24V	4	2,5
	7	4
48V	10	1,5
	20	2,5
	30	4
110V	40	1
	60	1,5
	100	2,5
	150	4
220V	150	1
	250	1,5
	400	2,5
	600	4
380V 440V	500	1
	750	1,5
	1200	2,5



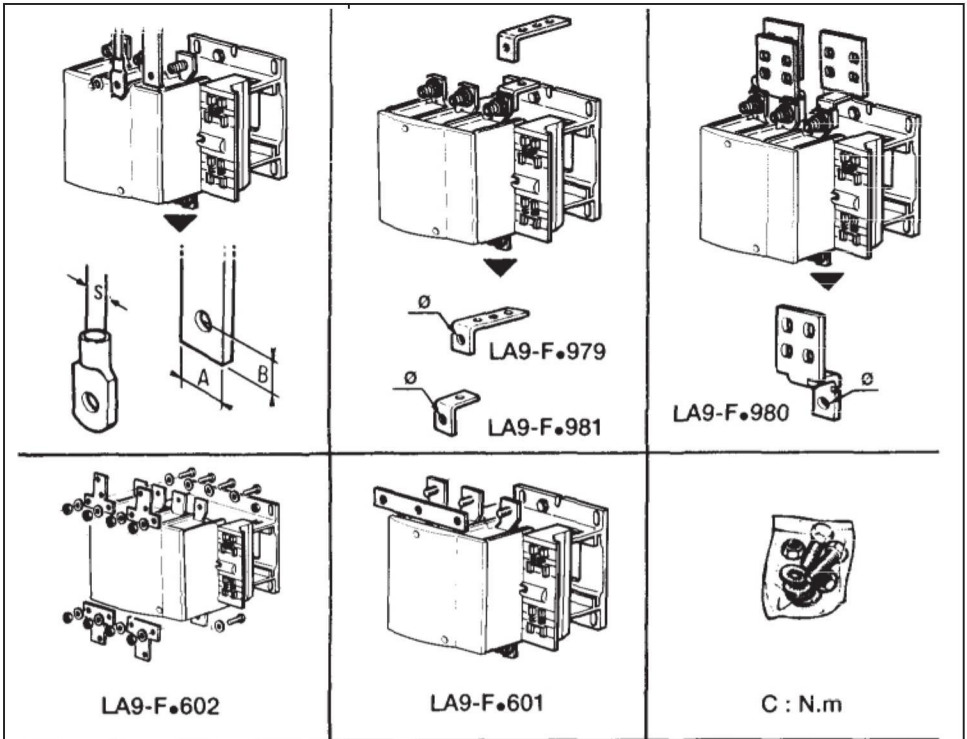

CR1-F400 ... 630		
LX-F ~ ou ≡	L ≤ ... m	S ≥ ... mm ²
48V	4	1,5
	6	2,5
	10	4
110V	15	1
	20	1,5
	40	2,5
	60	4
220V	60	1
	90	1,5
	150	2,5
	250	4
380V 440V	180	1
	270	1,5
	500	2,5



	150	185	265	400	500	630
A (mm)	≤25	≤25	≤30	≤30	≤40	≤60
B (mm)	12,5	12,5	15	15	20	25
Ø (mm)	9	9	11	11	11	13
S (mm ²)	120	150	240	2 X 150	2 X 240	-
c (Nm)	18	18	35	35	35	58

inches = mm x 0.0394

lb-in = N.m x 8.85

CR1-F ▼	3 x 	3 x 	3 x 	4 x 	1 x 
150	LA9-FG981	LA9-FG979	LA9-FG980	LA9-FG602	LA9-FG601
185	LA9-FG981	LA9-FG979	LA9-FG980	LA9-FG602	LA9-FG601
265	LA9-FJ981	LA9-FJ979	LA9-FJ980	LA9-FH602	LA9-FH601
400	LA9-FJ981	LA9-FJ979	LA9-FJ980	LA9-FH602	LA9-FH601
500	LA9-FK981	LA9-FK979	LA9-FK980	LA9-FK602	LA9-FK601
630	LA9-FL981	LA9-FL979	LA9-FL980	LA9-FL602	LA9-FL601

Ne pas manipuler sous-tension puissance
Do not operate with supply on
Nicht unter Spannung On betätigen
No manipolare sotto tensione di potenza
No manipular en tension
Запрещается эксплуатация при включенной подаче

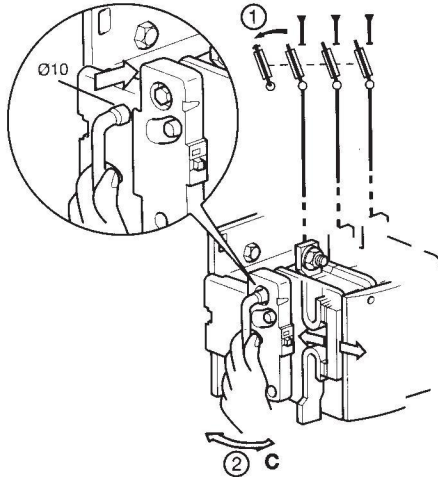
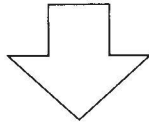
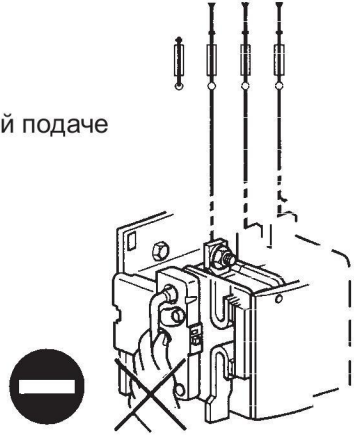

C (maxi / макс. / 最大) = 10 N.m (88.5 lb-in) for CR1 F150...F185

Contrôle d'usure des contacts
 Contact wear indicator
 Prüfung der Abnutzung der Kontakte
 Controllo dello stato di usura dei contatti
 Control del desgaste de los contactos
 Индикатор износа контактов

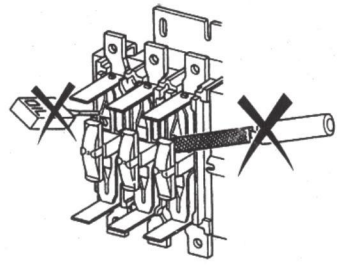
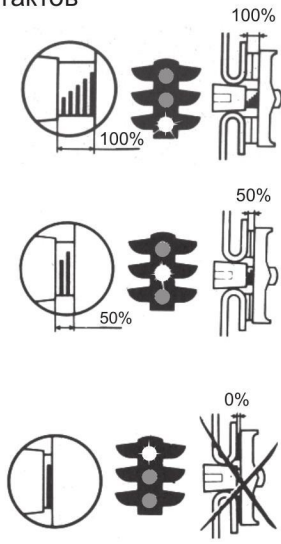
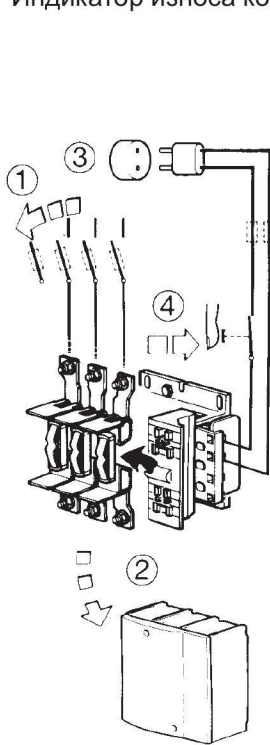

■ Le noircissement des contacts et des boîtiers d'arc est un phénomène naturel qui n'altère pas le fonctionnement de l'appareil.

■ The blackening of the contacts and the arc-boxes is a natural consequence which occurs during normal operation, and does not effect the functioning of the product.

■ Die Schwärzung an den Kontakten und in der Lichtbogenkammer ist ein normales Phänomen und hat keine Auswirkungen auf die Funktionsweise des Gerätes.

■ L'annerimento dei contatti e delle camere spegni-arco è un fenomeno naturale che non altera il funzionamento del l'apparecchio.

■ El ennegrecimiento de los contactos y de las cámaras de arco es un fenómeno natural que no altera el funcionamiento del aparato.

■ Почернение контактов и дуговых коробов является естественным следствием, которое возникает во время обычной работы и не влияет на функционирование продукта.

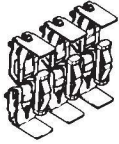

LA5-FF431 (F150)
 LA5-FG431 (F185)
 LA5-FH431 (F265)

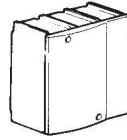

LA5-F15050 (F150)
 LA5-F18550 (F185)
 LA5-F26550 (F265)

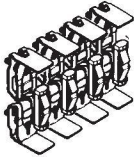

LA5-FF441 (F1504)
 LA5-FG441 (F1854)
 LA5-FH441 (F2654)

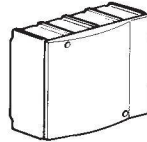

LA5-F150450 (F1504)
 LA5-F185450 (F1854)
 LA5-F265450 (F2654)

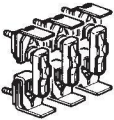

LA5-F400803 (F400)
 LA5-F500803 (F500)

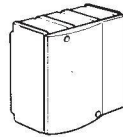

LA5-F40050 (F400)
 LA5-F50050 (F500)

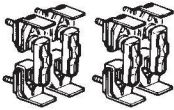

LA5-F400804 (F4004)
 LA5-F500804 (F5004)

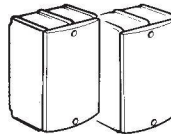

LA5-F400450 (F4004)
 LA5-F500450 (F5004)

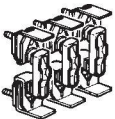

LA5-F630803 (F630)

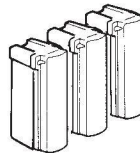

LA5-F63050 (F630)

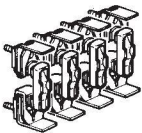

LA5-F630804 (F6304)

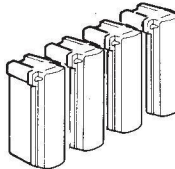

LA5-F630450 (F6304)



<p>The product's manufacture date is coded P^PY^YW^WD, where:</p> <ul style="list-style-type: none">● PP: plant code● YY: year of manufacture● WW: week of manufacture● (D: weekday of manufacture (Monday = 1))	<p>La date de fabrication du produit est codée P^PY^YW^WD, avec:</p> <ul style="list-style-type: none">● PP: code usine● YY: année de fabrication● WW: semaine de fabrication● (D: jour de fabrication dans la semaine (lundi = 1))	<p>La fecha de fabricación del producto está codificada P^PY^YW^WD, donde:</p> <ul style="list-style-type: none">● PP: código de la planta● YY: año de fabricación● WW: semana de fabricación● (D: día de la semana de fabricación (lunes = 1))	<p>Das Herstellungsdatum des Produkts ist folgendermaßen codiert: P^PY^YW^WD</p> <p>Wobei:</p> <ul style="list-style-type: none">● PP: Werkscode● YY: Herstellungsjahr● WW: Herstellungswoche● (D: Herstellungstag (Montag = 1))
<p>La data di fabbricazione del prodotto è indicata con il codice P^PY^YW^WD, dove:</p> <ul style="list-style-type: none">● PP: codice stabilimento● YY: anno di fabbricazione● WW: settimana di fabbricazione● (D: giorno della settimana in cui il prodotto è stato fabbricato (lunedì = 1))	<p>A data de fabrico do produto está sob a forma de código P^PY^YW^WD, onde:</p> <ul style="list-style-type: none">● PP: código da fábrica● YY: ano de fabrico● WW: semana de fabrico● (D: dia da semana de fabrico (Segunda-feira = 1))	<p>Дата производства продукта закодирована в формате P^PY^YW^WD, где:</p> <ul style="list-style-type: none">● PP: код завода● YY: год производства● WW: неделя производства● (D: день недели, когда был произведен продукт (понедельник = 1))	<p>产品制造日期采用如下代码 P^PY^YW^WD, 其中:</p> <ul style="list-style-type: none">● PP: 工厂代码● YY: 制造年份● WW: 第几周制造● (D: 星期几制造 (星期一 = 1))



W914683870131

Schneider Electric Industries SAS

35, rue Joseph Monier
CS30323
F - 92500 Rueil-Malmaison
<http://www.schneider-electric.com>

Уполномоченный поставщик в РФ:

АО «Шнейдер Электрик»

Адрес:

127018, г. Москва, ул. Двинцев, д.12, корп.1,

тел. +7 (495)777 99 88,

факс: +7 (495)777 99 94, 8-800-200-6446

www.schneider-electric.ru



W9 1468387 0131 07

12/12



RSPSupply - 1-888-532-2706 - <https://www.RSPSupply.com>
See the product details here